

## 100MHz, 20kV DC / 40kV PULSE, 1000:1 HIGH VOLTAGE PASSIVE PROBE

### ■ FEATURES

- CeramCore™ Hybrid Probe
- Coaxial Design
- Optional Read-Out
- System Bandwidth >100MHz
- 20kV DC incl. AC Peak
- Up to 40kV Pulse Peak
- Optional Cable Length up to 12m

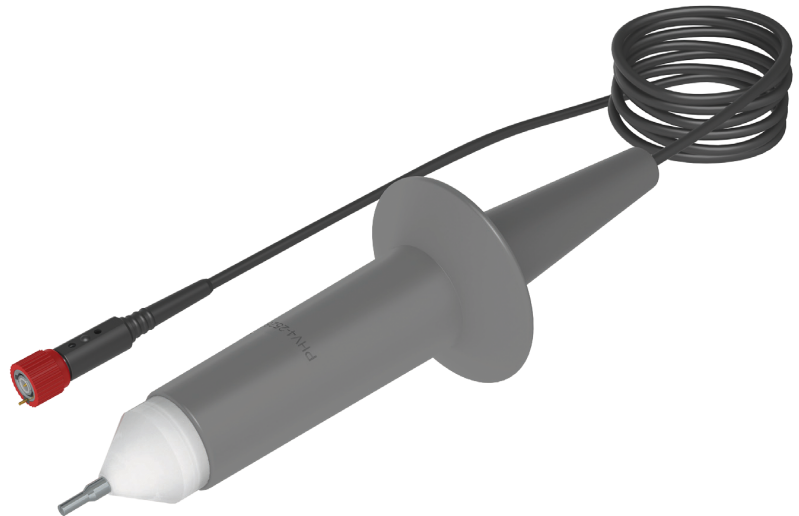

High Voltage Probes of the PHV4002 Series are the most powerful probes for performance measurements of fast high voltage signals. Applications include measurements of ignition voltages, glitch-detection in low-voltage and medium-voltage systems, laser technology, drive technology, large-scale operations of frequency converters and many more. With a system bandwidth greater than 100 MHz, even fast events can be captured.

### ■ SPECIFICATIONS

Attenuation Ratio <sup>(1)</sup> :	1000:1 ±2% at DC
Voltage Coefficient:	0.00025%/V (typical)
System Bandwidth:	100MHz (-3dB)
System Risetime:	3.5ns (10% – 90%) (typical)

Maximum non-destructive Input Voltage

Direct Current:	20kV DC
Alternating Current:	14kV AC rms 50/60Hz Sinus
HF-Sinus-AC:	see "Typical Voltage Derating" Graph
Pulse Voltage:	40kV Pulse (observe graphs on page 2)

(1) Connected to oscilloscope with an Input Impedance of 1MΩ ±1%.

The instrument should have warmed up for at least 20 minutes and the environmental conditions must not exceed the specified limits of the probe.

### ■ VOLTAGE DERATING

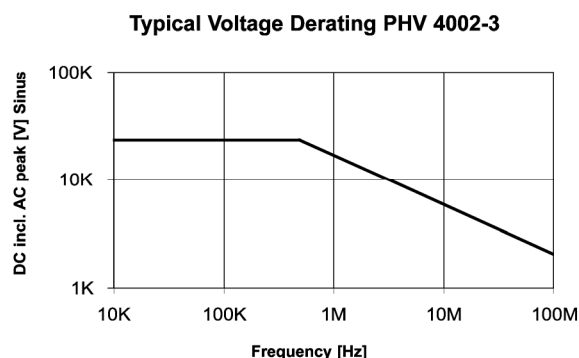

Note that the max. Input Voltage rating of the probe decreases as the frequency of the applied signal increases.

## ▪ DATA ON MAX. NON-DESTRUCTIVE PULSE VOLTAGES

For Pulse Voltages make sure to always comply with the data shown below.

PHV 4002-3 DC incl. AC peak vs. Peak Pulse Voltage

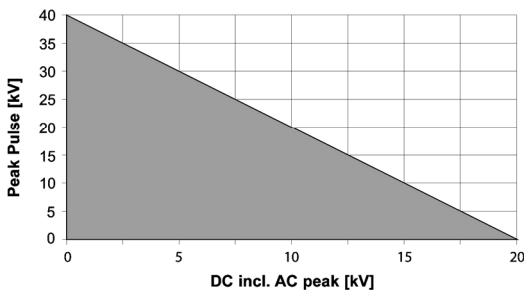

Maximum Pulse Derating PHV 4002-3

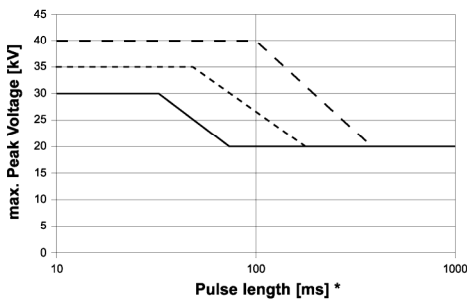

Duty Cycle

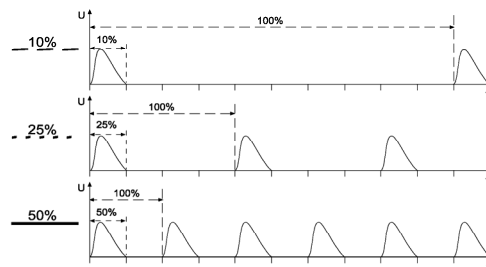

\* Values at 10ms also apply to all Pulse Durations smaller than 10ms.

## ▪ ELECTRICAL CHARACTERISTICS

Input Resistance (system):	100MΩ ±1%
Input Capacitance (system):	3pF (typical)
Compensation Range:	10pF – 50pF (typical)
Input Coupling of the Measuring Instrument:	1MΩ AC/DC

## ▪ INPUT IMPEDANCE

Typical Input Impedance PHV 4002-3

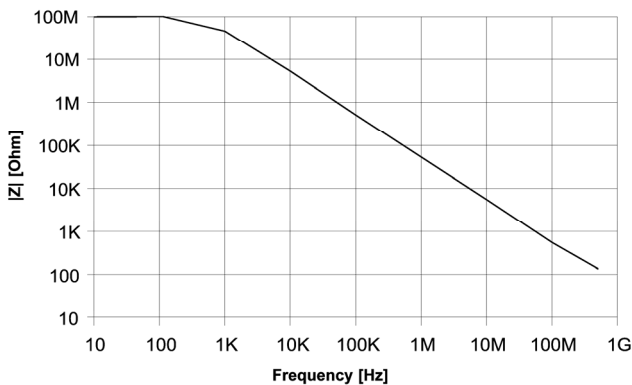

Note that the Input Impedance of the probe decreases as the frequency of the applied signal increases.

## MECHANICAL CHARACTERISTICS

Weight (probe only):	465g
Cable Length:	3m
Probe Tip Diameter:	4mm Thread Terminal (M4)
Ground Connector:	2.5 mm Riveting Nut (M2.5)

## DIMENSIONS

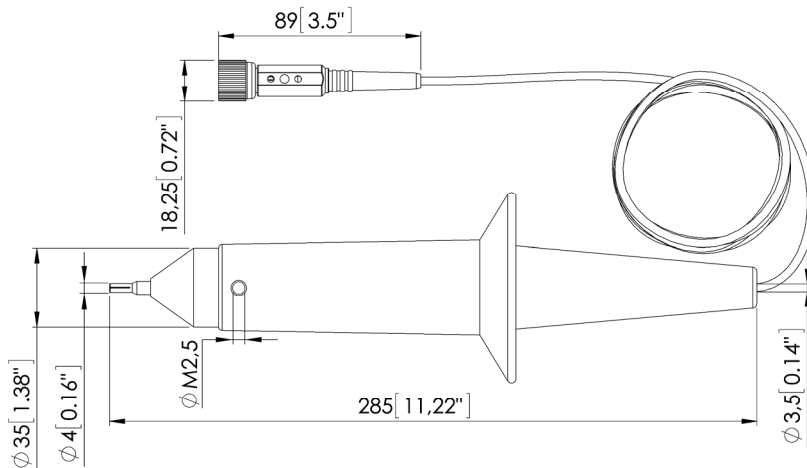

## ENVIRONMENTAL SPECIFICATIONS

Altitude	operating:	up to 2000m
	non-operating:	up to 15000m
Temperature range	operating:	0°C to +50°C
	non-operating:	-40°C to +71°C
Maximum relative humidity	operating:	80% relative humidity for temperatures up to +31°C, decreasing linearly to 40% at +50°C

## SCOPE OF DELIVERY

- Adjustment Tool HQ
- Ground Lead to Safety-Aligator clip 15cm
- Instruction Manual
- Probe
- Screw-In Hook PHV4002 Ni
- Solid Tip HV 4mm

### Disclaimer

The information given in this data sheet is technical data, not assured product characteristics. It has been carefully checked and is believed to be accurate; however, no responsibility is assumed for inaccuracies. The user has to ensure by adequate tests that the product is suitable for his application regarding safety and technical aspects. hivolt.de GmbH & Co. KG does not assume any liability arising out of the application or use of any product described.

### Safety Advice

Design, installation and inspection of machinery and devices carrying high voltage require accordingly trained and qualified personnel. Appropriate safety rules and directives must be complied with.

Improper handling of high voltage can mean severe injuries or death and may cause serious collateral damage!